



memmert
Experts in Thermostatics

Waterbaths & Oilbaths

PRECISION AND SAFETY BROUGHT TO THE POINT.



WATERBATH W

OILBATH O

100% ATMOSAFE. MADE IN GERMANY.

www.memmert.com | www.atmosafe.net



Uniquely precise and reliable.

Of course always at the right temperature

Since in 1947 the first Memmert hot air steriliser has left our facilities, we have pursued one essential goal in the development of our thermostatic ovens and thermostatic baths: controlled atmosphere. Inseparably linked to this are reliability, optimum temperature homogeneity and stability, user friendliness and an outstanding price/performance ratio. This promise to customers and users is called: 100% AtmoSAFE.

It is the modern control technology which makes Memmert's waterbaths and oilbaths unparalleled in precision. At least 2-fold over-temperature protection guarantees optimum safety for all baths. You can combine programme start delay and hold time, for baths of the Excellent class even setpoint-dependent. Made by professionals for professionals.



WATERBATHS AND OILBATHS

PAGE 4 TO 7

Six appliance sizes, two performance classes as well as WPE 45 with circulating pump

CONTROL TECHNOLOGY

PAGE 8 TO 9

The two performance classes Basic and Excellent fulfil all requirements in terms of precision, safety and comfort

PELTIER COOLING UNIT CDP 115

PAGE 10 TO 11

Saves valuable space in the laboratory and is suitable for all Memmert waterbaths: The cooling unit based on Peltier technology

TECHNICAL DATA

PAGE 12 TO 15

Waterbaths and Oilbaths, Peltier cooling unit as well as options and accessories



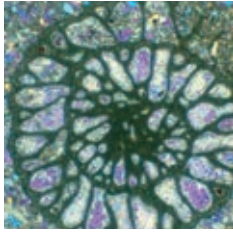

Memmert **WATERBATHS W // OILBATHS O** are unparalleled in terms of precision, safety and comfort. In the Excellent version, our waterbaths and oilbaths are perfectly suited for professional applications in quality management and for technical guidelines and standards.



ONE 29



WPE 45



WNE 22

WATERBATHS BASIC WNB

7 / 10 / 14 / 22 / 29 / 45 litres

WNB 7 - 45: +10 °C up to +95 °C and boiling stage

2-stage safety through relay switch-off close to the setpoint (approx. +10 °C) and mechanical temperature limiter TB at +135 °C

optional with Peltier cooling unit

WATERBATHS EXCELLENT WNE

7 / 10 / 14 / 22 / 29 / 45 litres

WNE 7 - 45: +10 °C up to +95 °C and boiling stage

relay switch-off close to the setpoint (approx. +10 °C) and mechanical temperature limiter TB at +135 °C

additional electronic temperature controller TWW as standard or alternatively temperature limiter TWB adjustable in the setup

optional with Peltier cooling unit

WATERBATH EXCELLENT WITH CIRCULATING PUMP WPE

45 litres

WPE 45: +10 °C up to +95 °C and boiling stage (only with pump switched off)

relay switch-off close to the setpoint (approx. +10 °C) and mechanical temperature limiter TB at +135 °C

additional electronic temperature controller TWW as standard or alternatively temperature limiter TWB adjustable in the setup

optional with Peltier cooling unit

OILBATHS EXCELLENT ONE

7 / 10 / 14 / 22 / 29 / 45 litres

ONE 7 - 45: +20 °C up to +200 °C

relay switch-off close to the setpoint (approx. +10 °C) and mechanical temperature limiter TB at +230 °C

additional electronic temperature limiter TWB adjustable as standard





WATERBATHS BASIC WNB
WATERBATHS EXCELLENT WNE, WPE
OILBATHS ONE

Memmert waterbaths and oilbaths – that is the combination of high-grade anti-corrosion stainless steel with the latest electronics, for maximum functional security and decisive advantages in convenience and ease of operation. With a setpoint resolution of 0.1 K, indicated temperature to the nearest 0.1 K, and timer programming of switch-on delay and hold time in 1-minute steps, the accuracy of Memmert thermostatic baths is carried to a new dimension.





E – an excellent decision!

In the Excellent version the Memmert waterbaths and oilbaths perfectly conform to professional requirements of quality management and to technical regulations and standards:

- Excellent overtemperature protection and digital level monitor to guarantee secure long-term tests – with visual and audible alarm signals
- Excellent quality assurance on standardised or documented material tests through ± 5 K recalibration facility on the controller
- Excellent user friendliness through programmable start of hold time only after reaching the temperature setpoint

Dual-use heating design

The tank does not contain any heating elements liable to corrode or attract lime deposits. Fully protected against moisture and yet close to the tank contents, the heating is located underneath deep-drawn and easy-to-clean ribs. This form of construction generates natural turbulence and therefore better temperature distribution in the bath (see sketch). Heating from three sides ensures optimal temperature uniformity. At 95 °C water temperature the deviation over the entire bath is less than 0.36 °C!

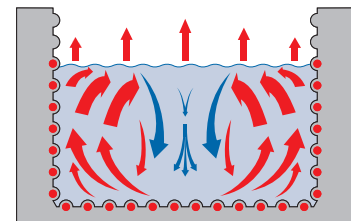
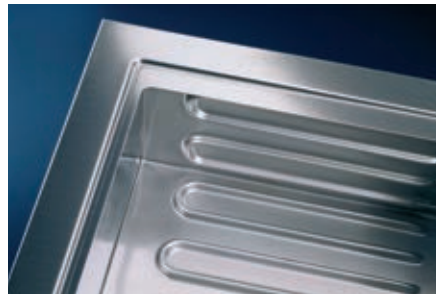

optimal temperature uniformity

Water level control

Where an almost constant water level is required, each thermostatic bath can optionally be fitted with a level control device. The bath is connected by hoses to the mains water system and is continuously supplied drop-wise with additional water. An overflow permits maintaining two different water levels.

Two baths in one

The optional electronically controlled shaking device is available in two versions for different bath sizes (requires special gable cover). It converts the models from size W14 upwards into an adjustable-speed shaking bath with horizontal movement from 35 to 160 strokes per minute.

An electronic blockage protection switches off the motor within fractions of a second on a sudden overload.





MODERN CONTROL TECHNOLOGY Because there are such great variations in thermal tests and tested materials, Memmert offers waterbaths in two performance classes. For warming paraffin wax, for example, the Basic waterbath is usually adequate. The Excellent version on the other hand supports reliable and precise testing processes; e.g. safety glass for the motor and aircraft industries is tested in the waterbath for its moisture absorption, the oilbath with its higher temperatures up to +200 °C is ideal for testing and calibrating temperature sensors, among others.



The functions of the Basic version WNB



- ① **Normal operation**
Press the SET key, select the setpoint temperature
- ② **Delayed switch-on**
Go home in the evening; in the morning the bath is already at temperature.
From 0 to 99:59 hrs (Excellent: 999 hrs) setting accuracy: 1 minute
- ③ **Programmable hold time**
Select to the nearest minute how long the waterbath should hold the temperature.
From 0 to 99:59 hrs (Excellent: 999 hrs) setting accuracy: 1 minute
- ④ **Visual alarm**
If the setpoint temperature is exceeded by more than 10 °C the monitor relay permits emergency operation, indicated visually by the flashing alarm signal. If the factory-set maximum temperature is exceeded the mechanical temperature limiter TB switches off the heating permanently and the alarm symbol is on continuously.

The functions of the Excellent version WNE – WPE – ONE

Excellent versions offer everything included in the Basic versions and in addition still more convenience and security: start of hold period only after reaching the setpoint, re-calibration on the controller.



- ① **Electronic overtemperature protection**
Set the monitoring temperature with 0.1 °C accuracy up to 10 °C above nominal temperature. If there should be a fault, you can choose in setup through standard function selection between continuation of the procedure (TWW) or abort (TWB).
- ② **Level**
This flashes on low liquid level. At the same time there is an audible alarm and the heating is switched off automatically.
- ③ **Audible signals**
There is a brief beep at programme end and also as input acknowledgement.
On overtemperature and low liquid level there is an audible signal together with a visual alarm.
- ④ **Circulating pump** (WPE 45 only)
The circulating pump in the WPE 45 optimises the thermal uniformity of the large water volume!

Push and turn – intuitive operation of the control

Memmert carries out the entire development, production and assembly of all baths in-house. This allows electronic development and product design to be matched exactly to customer requirements.

In the Basic versions an electronic PID controller ensures that the selected temperature is accurately reached and maintained. The multi-functional fuzzy-supported PID control on the Excellent versions guarantees maximum security. Two high-grade platinum sensors are responsible for temperature control and for monitoring temperature and level. Like a climbing team on a rope they communicate with each other and ensure uninterrupted fault-free temperature control; the high-grade 4-wire circuit guarantees uncorrupted transmission of measurements.

The result can readily be seen behind the easy-clean glass window: all essential settings and operating states are clearly displayed.



PELTIER COOLING UNIT CDP 115 Worldwide only from Memmert! The innovative Peltier cooling unit CDP 115 enables you to work exactly at temperatures below room temperature and puts an end to unwieldy external cooling units. Space-saving, environmentally friendly and precise in its temperature control, it fits on the smallest as well as on the largest Memmert waterbath! Your benefits: Compact design, user-friendly snap-on technology and exact controllability down to ± 0.1 K.





Cooling with Peltier – sustainable and energy-saving

If constant set temperatures close to ambient are required in the waterbath, Peltier elements cool down the tempering medium in a way that is economical, eco-friendly and precise.

- No gases or fluids (coolants) required
- Quiet and smooth-running
- High control precision
- Saves valuable space in the laboratory

A cooling unit for all Memmert waterbaths!

The CDP 115 extends the temperature range of the Memmert waterbaths from +10 °C to +95 °C. It can be fitted to all appliances from 7 to 45 litres in capacity, quickly and without technical knowledge. Simply hang it onto the flaps of the gable cover hinge, and that's it! The water is continually circulated via two Norpren tubes, cooling it down. Simultaneous use of the SV shaking device is not a problem.

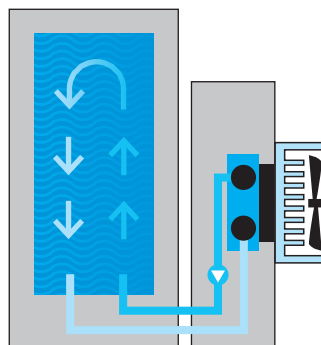

Fluid circulation



Safety and precision are involved, as always!

The cooling unit CDP 115 has its own main switch. The temperature is controlled via the electronic controller of the waterbath and achieves an impressive precision of ± 0.1 K. A frost protection unit we have developed switches off the cooling element if there is too little fluid flow, thus protecting the Peltier flow-through cooler from freezing. After the disruption has been cleared up, the frost protection switch resets automatically.

Average cooling speed

Filling volumes / bath size	Average cooling down speed*
7 litres / WN...7	14.1 K/h
10 litres / WN...10	9.9 K/h
14 litres / WN...14	7.1 K/h
22 litres / WN...22	4.5 K/h
29 litres / WN...29	3.4 K/h
45 litres / WN...45	2.2 K/h

* At a room temperature of +20 °C

WATERBATHS WNB, WNE, WPE / OILBATHS ONE

according to DIN 12 876-3, EN 61010, EN 61010-1 (IEC 61010-1), 61010-2-010 Standard appliances are safety-approved and bear the test marks:



Standard equipment

Container:	deep-drawn, laser-welded stainless steel interior with integrated large-area heating system on three sides (no disturbing fittings)
Housing:	textured stainless steel
Connection:	mains cable with plug
Installation:	4 feet

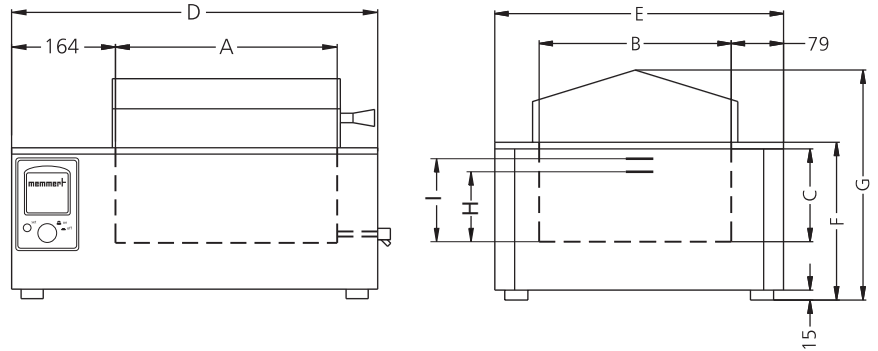

Model sizes/Description			7	10	14	22	29	45
Stainless steel container	Contents	approx. l	7	10	14	22	29	45
	Length	(A) mm	240	350	350	350	590	590
	Width	(B) mm	210	210	290	290	350	350
	Height	(C) mm	140	140	140	220	140	220
Textured stainless steel housing	Length	(D) mm	468	578	578	578	818	818
	Width	(E) mm	356	356	436	436	516	516
	Height (with flat cover)	(F) mm	238	238	238	296	238	296
	Height (with gable cover)	(G) mm	337	337	347	405	343	401
	Liquid level min.	(H) mm	97	97	97	177	105	177
	Liquid level max.	(I) mm	120	120	120	200	120	200
Further data	Electrical load W/O at 230 V, 50/60 Hz, WPE: 50 Hz	approx. W	1200	1200	1800	2000	2400	2800
	Working-temperature range W	°C	at least 5 (WNB/WNE) 15 (WPE) above ambient temperature up to +95 and additional boiling stage (WPE only with pump switched off)					
	Setting temperature range W	°C	+10 to +95 and boiling stage					
	Working-temperature range O	°C	at least 5 above ambient temperature up to +200					
	Setting temperature range O	°C	+20 to +200					
	Temperature variation W	K	+/- 0.1					
	Temperature variation O	K	+/- 0.3					
	Temperature distribution W	K	+/- 0.25					
Temperature distribution O	K	+/- 1						
Packing data	Net weight (with one cover option)	approx. kg	11	13	15	16	22	24
	Gross weight in Triwall carton	approx. kg	14	17	19	20	29	31
	Length	approx. cm	57	67	67	67	91	91
	Width	approx. cm	45	45	53	53	61	61
	Height	approx. cm	42	38	40	46	40	46
Order No. Waterbaths								
WNB = Waterbath, Natural Circulation, temperature controller BASIC			WNB7	WNB10	WNB14	WNB22	WNB29	WNB45
WNE = Waterbath, Natural Circulation, temperature controller EXCELLENT			WNE7	WNE10	WNE14	WNE22	WNE29	WNE45
WPE = Waterbath, Pump Circulation, temperature controller EXCELLENT								WPE45
Order No. Oilbaths								
ONE = Oilbath, Natural Circulation, temperature controller EXCELLENT			ONE7	ONE10	ONE14	ONE22	ONE29	ONE45

Options	7	10	14	22	29	45	
Water level control (for WNB, WNE, WPE)	L3						
Works calibration certificate (WNE, WPE at +37 °C, ONE at +160 °C)	D00123						
Accessories	7	10	14	22	29	45	
     	Fitted stainless steel gable cover for condensate drainage	B02686	B02687	B02688	B02691		
	Stainless steel gable cover for shaking device (14/22 and 29/45)	–		B02643	B04390		
	Stainless steel flat cover with openings and concentric ring sets Number of openings/Ø mm	B02680 1/147	B02681 3/107	B02682 6/87	B02684 8/107		
	Stainless steel flat cover with openings and concentric ring sets Number of openings/Ø mm	–		–	B02685 4/147		
	Shelf reversible for 2 heights (30 or 60 mm)	E02893	E02894	E02895	E02896		
	Portable stainless steel rack for 10 baby bottles Maximum capacity each bath	– –	E02066 1	E02066 2	– –	E02066 4	– –
	Shaking device incl. support frame, speed from 35 to 160 strokes per minute (horizontal back/forth movements), requires special gable cover for shaking device	–		SV1422	SV2945		
	Support basket with perforated mounting shelf (stainless steel) with grid perforations to take clips for conical flasks	–		B02782	B04397		

SPECIAL EQUIPMENT

Accessories

7

10

14

22

29

45

Racks for models **14, 22, 29, 45** with shaking device

Rack for 216 test tubes Ø 14.5 mm		–	B04399
Rack for 110 test tubes Ø 14.5 mm	–	B02778	–
Rack for 180 test tubes Ø 18 mm		–	B04400
Rack for 90 test tubes Ø 18 mm	–	B02779	–
Rack for 54 test tubes Ø 32 mm		–	B04401
Rack for 25 test tubes Ø 32 mm	–	B02780	–

Test tube racks for models **7**

56 holes (7x8 rows), Ø 18 mm; Maximum number of test tube racks: 1	B02781	–
24 holes (3x8 rows), Ø 18 mm; Maximum number of test tube racks: 2	B02783	–

Test tube racks for models **10 to 45**,
Holes in **2 rows**

40 holes, Ø 10 mm, width 40 mm	E02028
40 holes, Ø 12 mm, width 40 mm	E02013
24 holes, Ø 14.5 mm, width 43 mm	E02014
24 holes, Ø 18 mm, width 50 mm	E02022
20 holes, Ø 21 mm, width 55 mm	E02032
12 holes, Ø 32 mm, width 80 mm	E02034

Test tube racks for models **10 to 45**,
Holes in **3 rows**

60 holes, Ø 10 mm, width 50 mm	E02046
60 holes, Ø 12 mm, width 55 mm	E02049
36 holes, Ø 14.5 mm, width 60 mm	E02039
36 holes, Ø 18 mm, width 70 mm	E02019
30 holes, Ø 21 mm, width 80 mm	E02043

Test tube racks for models **10 to 45**,
Holes in **4 rows**

80 holes, Ø 10 mm, width 64 mm	E02057
80 holes, Ø 12 mm, width 75 mm	E02060
48 holes, Ø 14.5 mm, width 85 mm	E02056
48 holes, Ø 18 mm, width mm	E02051
40 holes, Ø 21 mm, width 110 mm	E02061

The maximum number of test tube racks
of equal width in your waterbath is calculated as follows:



W 10/14/22: Width of the bath : Width of the racks

W 29/45: Length of the bath : Width of the racks

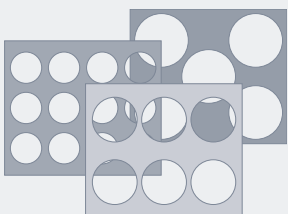
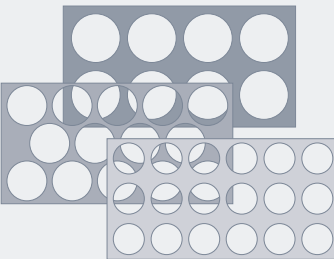

Accessories	7	10	14	22	29	45
 <p>Mounting shelves W14/22: 12 flasks 100 ml or 6 flasks 200/300 ml or 5 flasks 500 ml</p>	Clip for 100 ml flask; 18 flasks max.		–		B02692	
	Clip for 100 ml flask; 12 flasks max.		–		B02692	
 <p>Mounting shelves W29/45: 18 flasks 100 ml or 14 flasks 200/300 ml or 8 flasks 500 ml</p>	Clip for 200 ml flask; 14 flasks max.		–		B02693	
	Clip for 200 ml flask; 6 flasks max.		–		B02693	
	Clip for 300 ml flask; 14 flasks max.		–		B02694	
	Clip for 300 ml flask; 6 flasks max.		–		B02694	
	Clip for 500 ml flask; 8 flasks max.		–		B02695	
Clip for 500 ml flask; 5 flasks max.		–		B02695		

PELTIER COOLING UNIT CDP 115

Model sizes/Description	7	10	14	22	29	45
  <p>Order No. Cooling Unit CDP 115 Peltier Cooling Unit for Waterbaths for temperatures below room temperature from +10 °C</p>	CDP115					
	Casing dimensions Height/Width/Depth	approx. mm	185/450/200			
	Electrical load at 230 V/115 V, 50/60 Hz	max. W	160			
	Effective cooling capacity	W	115			
	Pumping capacity of circulation pump for coolant	ml/Min	600			

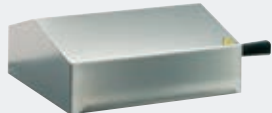
Accessories	7	10	14	22	29	45	
 	Installation and connection set for Peltier cooling device CDP 115 (including mounting bars for all different bath sizes)					B02770	
	Stainless steel flat cover for Peltier cooling device CDP 115 with openings and concentric ring sets		B24372	B24373	B04552	B04462	
	Number of openings/Ø mm		1/147	3/107	6/87	8/107	
Stainless steel gable cover for shaking device (14/22 and 29/45) and for Peltier cooling device CDP 115		B02641	B02642	B02643	B04390		



memmert
Experts in Thermostatics

YOUR MEMMERT PARTNER

HEATING AND DRYING OVENS

UNIVERSAL OVEN U

PASS-THROUGH OVEN UFP TS

PARAFFIN OVEN UNpa

STERILISER S

VACUUM OVEN VO

COOLED VACUUM OVEN VOcool

INCUBATORS

INCUBATOR I

CO₂ INCUBATOR INCOmed

COMPRESSOR-COOLED INCUBATOR ICP

PELTIER COOLED INCUBATOR IPP

STORAGE COOLED INCUBATOR IPS

CLIMATE CHAMBERS

CONSTANT CLIMATE CHAMBER HPP

HUMIDITY CHAMBER HCP

CLIMATE CHAMBER ICH

ENVIRONMENTAL TEST CHAMBER CTC/TTC

WATERBATHS / OILBATHS

WATERBATH W

OILBATH O

Memmert GmbH + Co. KG
P.O. Box 1720 | D-91107 Schwabach
Tel. +49 9122 925-0 | Fax +49 9122 14585
E-Mail: sales@memmert.com
facebook.com/memmert.family
The platform for experts: www.atmosafe.net